

Adept Medical Product Codes & Maintenance

Issue Date: 03/2026

CONTENTS

Product & Component Codes · Carton Dimensions & Weight · Maintenance

- | | | | |
|----------|--------------------------------------|-----------|--|
| 2 | <i>MR Safe</i>
Adducted Arm Scoop | 9 | <i>MR Safe</i>
Overhead Arm Support |
| 3 | Antegrade IR Platform | 10 | Prone Support |
| 4 | Drape Support | 11 | Retrograde IR Platform |
| 5 | Head Immobiliser | 13 | STARSystem |
| 7 | IR System | 16 | Storage System |
| 8 | Lower Leg Support | | |



[www.adeptmedical.com/
contact/service-and-repairs](http://www.adeptmedical.com/contact/service-and-repairs)

Visit our website for our Statement of Warranty:
[www.adeptmedical.com/resources/imaging_table_
accessories-statement_of_warranty.pdf](http://www.adeptmedical.com/resources/imaging_table_accessories-statement_of_warranty.pdf)



MR Safe
Adducted Arm Scoop
 AM1100

Product Code			Carton Dimensions L x W x H (cm)	Carton Weight (kg)
	Adducted Arm Scoop x 2	AM1100	66 x 35 x 14	2.7

Component Code

	Adducted Arm Support x 1	M6555
---	--------------------------	-------







Antegrade IR Platform

AM0440

Product Code			Carton Dimensions L x W x H (cm)	Carton Weight (kg)
	Antegrade IR Platform	AM0440	145 x 76 x 9	14.5

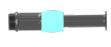
Component Codes

	Antegrade Main Platform	M6500
	Base	M6521
	Leg	M3664
	Leg Extension	M3693



Drape Support

AM1000

Product Code			Carton Dimensions L x W x H (cm)	Carton Weight (kg)
	Drape Support	AM1000	37 x 33 x 23	2.6

Component Codes

No spare parts available for this product. For breakages outside of our warranty, please contact us at adeptmedical@adept.co.nz to purchase a full product replacement.



Head Immobiliser

AM0800

Product Code			Carton Dimensions L x W x H (cm)	Carton Weight (kg)
	Head Immobiliser	AM0800	94 x 30 x 50	7

Component Codes

	Base Board Assembly	M8000
	Base Board	M8100
	Hood Support	M8200
	Adjustable Assembly	M8300
	Forehead Straps x 10	AM0830
	Hood Assembly + Forehead Straps x 10	AM0820

Maintenance Instructions



10mm

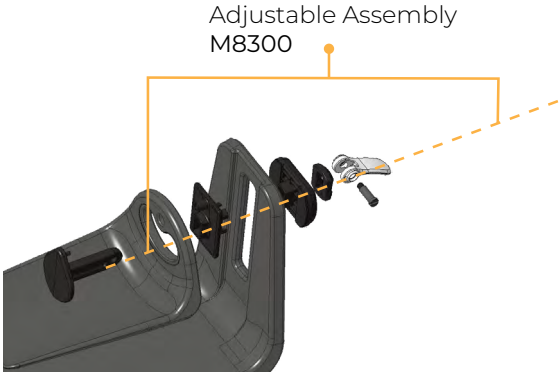
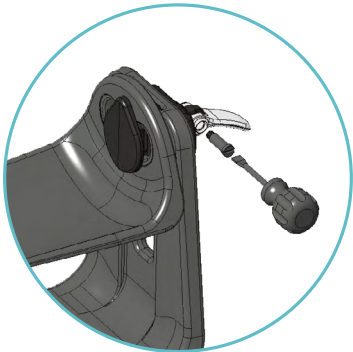

www.adeptmedical.com/imaging-table-accessories/head-immobiliser/training?group=maintenance-instructions







IR System

AM0180 · AM0500

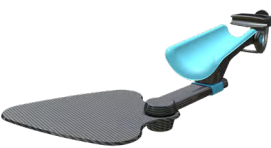
Product Codes			Carton Dimensions L x W x H (cm)	Carton Weight (kg)
	IR System	AM0500 + AM0180	50 x 37 x 31	5
	STARBoard + Extension Tray	AM0180	50 x 37 x 24	3.2
	IR Shield	AM0500	50 x 37 x 7	2.5
	Arm Support Pad	AM0171	32 x 18 x 9	0.5

Component Codes

	STARBoard	Refer to "Storage System" on page 7
	Extension Tray	M3334
	X-Ray Shield	AM0630
	Daggerboard	M3677

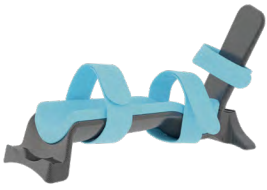

Lower Leg Support

AM3000

Product Code			Carton Dimensions L x W x H (cm)	Carton Weight (kg)
	Lower Leg Support	AM3000	61 x 29 x 13	3.3

Component Codes



	Foot Plate	M6511
	Leg Pad	M6512
	Support Base	M6516
	Leg Strap	M6513
	Foot Strap	M6514
	Table Strap	M6515



MR Safe

Overhead Arm Support

AM4000 · AM4100

Product Codes			Carton Dimensions L x W x H (cm)	Carton Weight (kg)
	Overhead Arm Support MR Safe	AM4000	60 x 44 x 14	3.5
	Overhead Arm Support MR Safe - Small	AM4100	60 x 44 x 14	3.5

Component Codes

	Armrest Wing MR Safe	M5504
	Armrest Wing MR Safe - Small	M5507
	Arm Strap x 10	AM0620
	Locking Leg Assembly MR Safe	M5505
	Daggerboard MR Safe	M5506

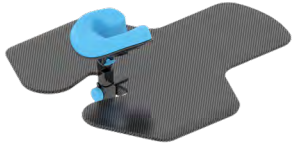

Prone Support

AM0700

Product Codes			Carton Dimensions L x W x H (cm)	Carton Weight (kg)
	Prone Support	AM0700	80 x 77 x 11	5.1

Component Codes

	Face Pad	M6531
	Face Pad Support	M6532
	Adjustable Assembly	M6533
	Base Board	M6534









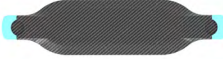

Retrograde IR Platform

AM0420 · AM0400 · AM0410
AM0460 · AM0450 · AM0470

Product Codes			Carton Dimensions L x W x H (cm)	Carton Weight (kg)
	Retrograde IR Platform + Extension	AM0420	145 x 85 x 9	17
	Retrograde IR Platform	AM0400	145 x 85 x 9	14.5
	IR Platform Extension	AM0410	77 x 69 x 4	4.3
	Retrograde IR Platform – Narrow + Extension	AM0460	145 x 85 x 9	14
	Retrograde IR Platform – Narrow	AM0450	145 x 85 x 9	13.5
	IR Platform Extension – Narrow	AM0470	77 x 69 x 4	3

Component Codes

	Retrograde Main Platform	M3660
	Retrograde Main Platform – Narrow	M3650
	Front Base	M3662
	Front Base – Narrow	M3651
	Rear Base	M3663
	Leg	M3664
	Leg Extension	M3693
	IR Platform Extension	AM0410
	IR Platform Extension – Narrow	AM0470

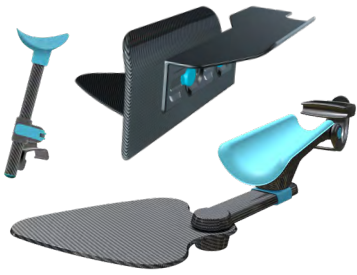

STARSystem

AM0160 • AM0100 • AM0140

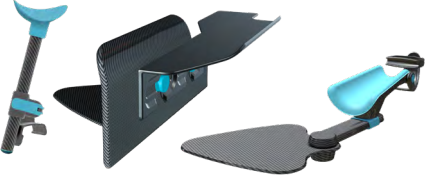
Product Codes	Carton Dimensions L x W x H (cm)	Carton Weight (kg)	
 <p>STARSystem</p>	AM0160	80 x 40 x 28	8.2
 <p>STARBoard + STARSupport</p>	AM0100	50 x 37 x 24	3
 <p>STARTable</p>	AM0140	80 x 40 x 28	6.2
 <p>Arm Support Pad</p>	AM0171	32 x 18 x 9	0.5
 <p>STARSupport</p>	AM0130	24 x 23 x 27	0.6

Component Codes

STARBoard

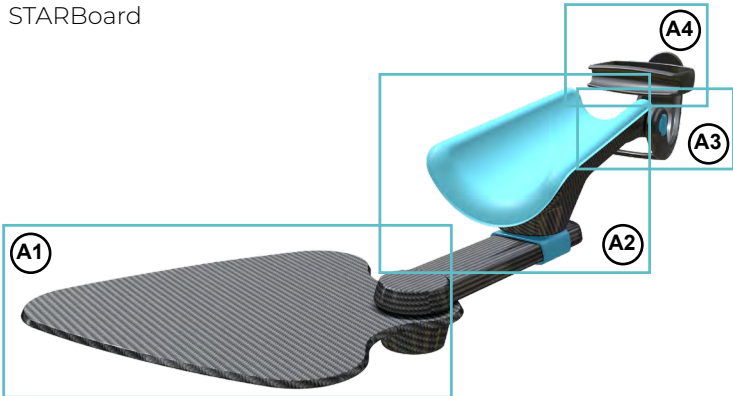

(B) (C) STARTable



(D) STARSupport



STARBoard

(A1)

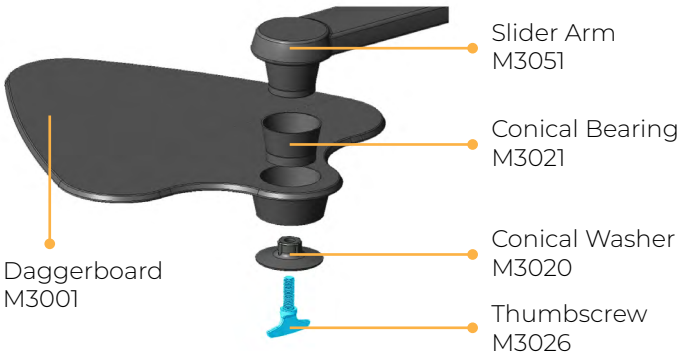

(A2)

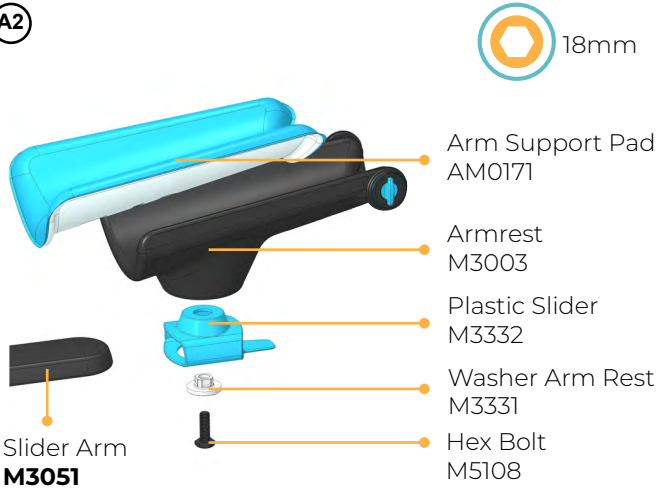

(A3)



(A4)



STARTable

(B) (C)

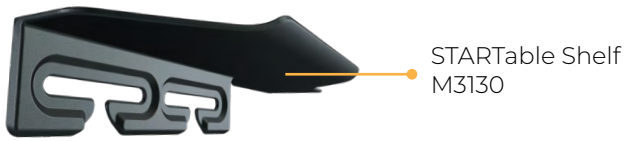

STARSupport

(D)



Maintenance Instructions

STARBoard

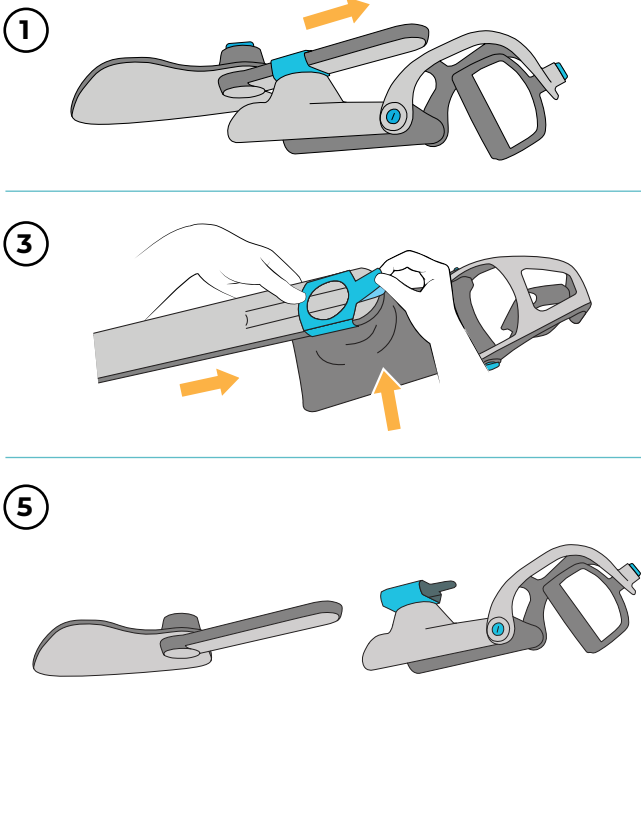



www.adeptmedical.com/imaging-table-accessories/starsystem/training?group=maintenance-instructions



Storage System

AM0001-1 • AM0001-2

Product Codes			Carton Dimensions L x W x H (cm)	Carton Weight (kg)
	Storage System Single	AM0001-1	23 x 17 x 8	0.4
	Storage System Double	AM0001-2	23 x 17 x 8	0.5



Medical
Supporting you

